

DMP 321

Industrial Pressure Transmitter

Stainless Steel Sensor

accuracy according to IEC 60770:
standard: 0.25 % FSO
option: 0.1 % FSO



Nominal pressure

from 0 ... 100 mbar up to 0 ... 600 bar

Output signals

2-wire: 4 ... 20 mA

3-wire: 0 ... 20 mA / 0 ... 10 V

others on request

Special characteristics

- ▶ perfect thermal behaviour
- ▶ excellent long-term stability
- ▶ compact design

Optional versions





- ▶ IS-version
Ex ia = intrinsically safe for
gases and dusts
- ▶ welded pressure sensor
- ▶ customer specific versions

The pressure transmitter DMP 321 is the consistent further development of our in many applications approved DMP 331. It shows an improved signal behaviour and sets new standards in the industrial class.

Its metallic diaphragm made of stainless steel (1.4435 / 316L) offers a good corrosion resistance in many industrial processes.

The modular device concept allows to combine different pressure ranges with a variety of electrical and mechanical connections. Thus, a diversity of variations is created, meeting almost all requirements in industrial applications.

Preferred areas of use are

-  Plant and machine engineering
-  Environmental engineering
-  Energy industry
-  Mobile hydraulics



Input pressure range												
Nominal pressure gauge	[bar]	-1...0	0.10	0.16	0.25	0.40	0.60	1	1.6	2.5	4	6
Nominal pressure absolute	[bar]	-	-	-	-	0.40	0.60	1	1.6	2.5	4	6
Overpressure	[bar]	5	0.5	1	1	2	5	5	10	10	20	40
Burst pressure ≥	[bar]	7.5	1.5	1.5	1.5	3	7.5	7.5	15	15	25	50

Nominal pressure gauge / absolute	[bar]	10	16	25	40	60	100	160	250	400	600
Overpressure	[bar]	40	80	80	105	210	600	600	1000	1000	1000
Burst pressure ≥	[bar]	50	120	120	210	420	1000	1000	1250	1250	1800
Vacuum resistance		$p_N \geq 1$ bar: unlimited vacuum resistance $p_N < 1$ bar: on request									

Output signal / Supply	
Standard	2-wire: 4 ... 20 mA / $V_S = 10 \dots 32 V_{DC}$
Option IS-protection	2-wire: 4 ... 20 mA / $V_S = 12 \dots 28 V_{DC}$
Options 3-wire	3-wire: 0 ... 20 mA / $V_S = 14 \dots 30 V_{DC}$ 0 ... 10 V / $V_S = 14 \dots 30 V_{DC}$

Performance	
Accuracy ¹	standard: $\leq \pm 0.25$ % FSO option: $\leq \pm 0.1$ % FSO
Permissible load	current 2-wire: $R_{max} = [(V_S - V_{S min}) / 0.02 A] \Omega$ current 3-wire: $R_{max} = 500 \Omega$ voltage 3-wire: $R_{min} = 10 k\Omega$
Influence effects	supply: 0.05 % FSO / 10 V load: 0.05 % FSO / $k\Omega$
Long term stability	$\leq \pm 0.1$ % FSO / year at reference conditions
Response time	2-wire: ≤ 10 msec 3-wire: ≤ 3 msec

¹ accuracy according to IEC 60770 – limit point adjustment (non-linearity, hysteresis, repeatability)

Thermal effects (offset and span)	
Tolerance band	$\leq \pm 0.75$ % FSO
in compensated range	-20 ... 85 °C

Permissible temperatures	
Medium	-40 ... 125 °C
Electronics / environment	-40 ... 85 °C
Storage	-40 ... 100 °C

Electrical protection	
Short-circuit protection	permanent
Reverse polarity protection	no damage, but also no function
Electromagnetic compatibility	emission and immunity according to EN 61326

Mechanical stability	
Vibration	10 g RMS (25 ... 2000 Hz) according to DIN EN 60068-2-6
Shock	100 g / 11 msec according to DIN EN 60068-2-27

Materials	
Pressure port	stainless steel 1.4404 (316 L)
Housing	stainless steel 1.4404 (316 L)
Option compact field housing	stainless steel 1.4301 (304) cable gland M12x1.5, brass, nickel plated (clamping range 2 ... 8 mm)
Seals	standard: FKM options: EPDM (for $p_N \leq 160$ bar) welded version ² (for $p_N \leq 40$ bar) others on request
Diaphragm	stainless steel 1.4435 (316 L)
Media wetted parts	pressure port, seals, diaphragm

² welded version only with pressure ports according to EN 837 and NPT, $p_N \leq 40$ bar

Explosion protection (only for 4 ... 20 mA / 2-wire)	
Approvals DX19-DMP 321	IBExU 10 ATEX 1068 X / IECEx IBE 12.0027X zone 0: II 1G Ex ia IIC T4 Ga zone 20: II 1D Ex ia IIIC T135 °C Da
Safety technical maximum values	$U_i = 28 V_{DC}$, $I_i = 93 mA$, $P_i = 660 mW$, $C_i \approx 0 nF$, $L_i \approx 0 \mu H$, the supply connections have an inner capacity of max. 27 nF to the housing
Permissible temperatures for environment	in zone 0: -20 ... 60 °C with p_{atm} 0.8 bar up to 1.1 bar in zone 1 or higher: -40/-20 ... 70 °C
Connecting cables (by factory)	cable capacitance: signal line/shield also signal line/signal line: 160 pF/m cable inductance: signal line/shield also signal line/signal line: 1 $\mu H/m$
Miscellaneous	
Current consumption	signal output current: max. 25 mA signal output voltage: max. 7 mA
Weight	approx. 140 g
Installation position	any ³
Operational life	100 million load cycles
CE-conformity	EMC Directive: 2014/30/EU Pressure Equipment Directive: 2014/68/EU (module A) ⁴
ATEX Directive	2014/34/EU

³ Pressure transmitters are calibrated in a vertical position with the pressure connection down. If this position is changed on installation there can be slight deviations in the zero point for pressure ranges $p_N \leq 1 bar$.

⁴ This directive is only valid for devices with maximum permissible overpressure > 200 bar

Wiring diagrams

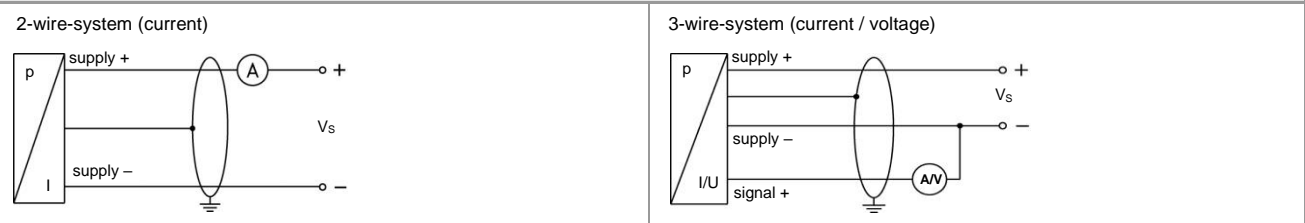

Pin configuration

Electrical connection	ISO 4400	Binder 723 (5-pin)	M12x1 / metal (4-pin)	Bayonet MIL-C-26482 (10-6)	
				2-wire	3-wire
Supply +	1	3	1	A	A
Supply -	2	4	2	B	D
Signal + (for 3-wire)	3	1	3	-	B
Shield	ground pin	5	4	pressure port	
Electrical connection	compact field housing		cable colours (IEC 60757)		
Supply +	V_{S+}		WH (white)		
Supply -	V_{S-}		BN (brown)		
Signal + (for 3-wire)	S+		GN (green)		
Shield	GND		GNYE (green-yellow)		

Electrical connections (dimensions mm / in)

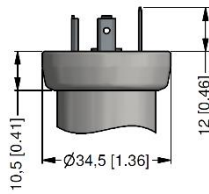

ISO 4400
(IP 65)

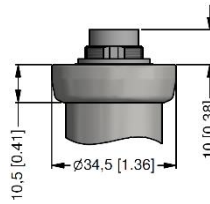

Binder series 723, 5-pin
(IP 67)

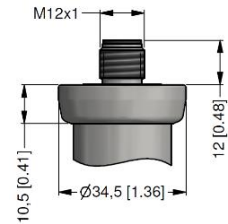

M12x1, 4-pin
(IP 67)

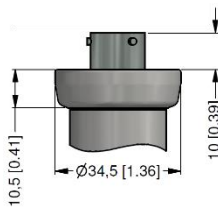

Bayonet MIL-C-26482 (10-6)
(IP 67)

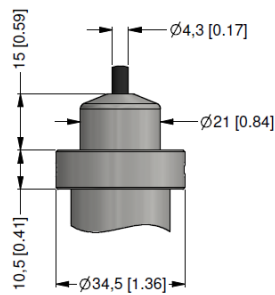

cable outlet with PVC cable
(IP 67)⁵

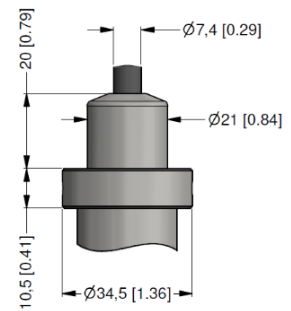

cable outlet, cable with
ventilation tube (IP 68)⁶

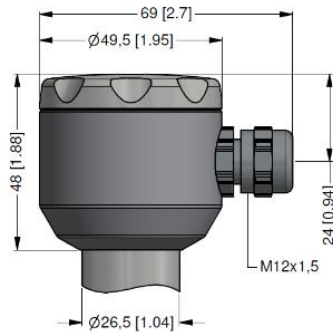

compact field housing
(IP 67)

⇒ universal field housing stainless steel 1.4404 (316 L) with cable gland M20x1.5 (ordering code 880) and other versions on request

⁵ standard: 2 m PVC cable without ventilation tube (permissible temperature: -5 ... 70 °C)

⁶ different cable types and lengths available, permissible temperature depends on kind of cable

Dimensions (mm / in)

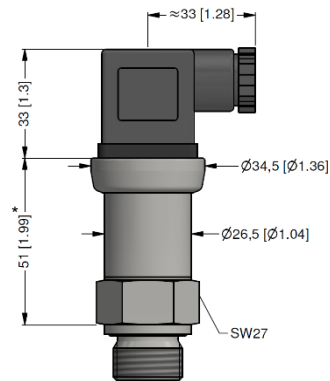

* for nominal pressure $p_N > 60$ bar increases the length of devices by 9 mm;
with electrical connection Bayonet MIL-C-26482 (10-6) increases the length of devices by 5 mm additionally

Mechanical connections (dimensions mm / in)

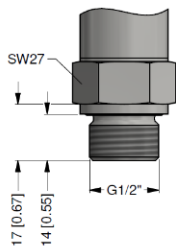

G1/2" DIN 3852

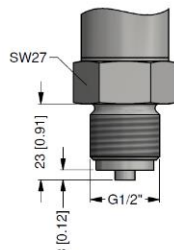

G1/2" EN 837

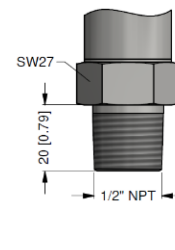

1/2" NPT

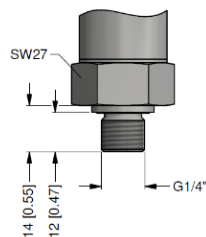

G1/4" DIN 3852

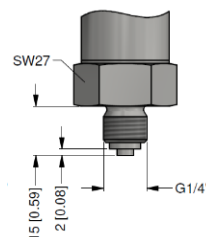

G1/4" EN 837

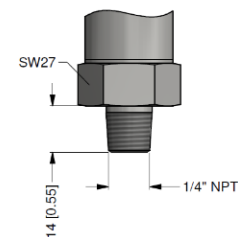

1/4" NPT

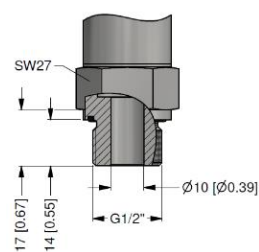

G1/2" open port DIN 3852
($p_N \leq 40$ bar)

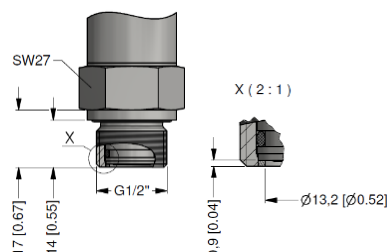

G1/2" flush DIN 3852
($p_N \leq 40$ bar)

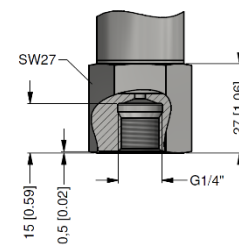

G1/4" DIN 3852
internal thread

↪ metric threads and other versions on request

© 2023 BD|SENSORS GmbH – The specifications given in this document represent the state of engineering at the time of publishing. We reserve the right to make modifications to the specifications and materials.

Ordering code DMP 321

DMP 321

<input type="text"/>	<input type="text"/>	<input type="text"/>	-	<input type="text"/>	<input type="text"/>	<input type="text"/>	<input type="text"/>	-	<input type="text"/>	<input type="text"/>	-	<input type="text"/>	<input type="text"/>	<input type="text"/>	<input type="text"/>	-	<input type="text"/>	<input type="text"/>
----------------------	----------------------	----------------------	---	----------------------	----------------------	----------------------	----------------------	---	----------------------	----------------------	---	----------------------	----------------------	----------------------	----------------------	---	----------------------	----------------------

Pressure									
gauge		1	1	5					
absolute ¹		1	1	6					
Input [bar]									
0.10 ¹				1	0	0	0		
0.16 ¹				1	6	0	0		
0.25 ¹				2	5	0	0		
0.40				4	0	0	0		
0.60				6	0	0	0		
1.0				1	0	0	1		
1.6				1	6	0	1		
2.5				2	5	0	1		
4.0				4	0	0	1		
6.0				6	0	0	1		
10				1	0	0	2		
16				1	6	0	2		
25				2	5	0	2		
40				4	0	0	2		
60				6	0	0	2		
100				1	0	0	3		
160				1	6	0	3		
250				2	5	0	3		
400				4	0	0	3		
600				6	0	0	3		
-1 ... 0				X	1	0	2		
customer				9	9	9	9		
Output									
4 ... 20 mA / 2-wire							1		
0 ... 20 mA / 3-wire							2		
0 ... 10 V / 3-wire							3		
intrinsic safety 4 ... 20 mA / 2-wire							E		
customer							9		
Accuracy									
standard:	0.25 % FSO						2		
option:	0.10 % FSO						1		
customer							9		
Electrical connection									
male and female plug ISO 4400							1	0	0
male plug Binder series 723 (5-pin)							2	0	0
cable outlet with PVC cable (IP67) ²							T	A	0
cable outlet,									
cable with ventilation tube (IP68) ³							T	R	0
male plug M12x1 (4-pin) / metal							M	1	0
Bayonet MIL-C-26482 (10-6); 2 wire							B	G	0
Bayonet MIL-C-26482 (10-6); 3 wire							B	G	4
compact field housing							8	5	0
stainless steel 1.4301 (304)									
customer							9	9	9
Mechanical connection									
G1/2" DIN 3852							1	0	0
G1/2" EN 837							2	0	0
G1/4" DIN 3852							3	0	0
G1/4" DIN 3852, internal thread							J	0	0
G1/4" EN 837							4	0	0
G1/2" DIN 3852									
with flush sensor ⁴							F	0	0
G1/2" DIN 3852 open pressure port ⁴							H	0	0
1/2" NPT							N	0	0
1/4" NPT							N	4	0
customer							9	9	9
Seal									
FKM									1
EPDM									3
without (welded version) ⁵									2
customer									9
Special version									
standard									0
customer									9

© 2023 BD|SENSORS GmbH - The specifications given in this document represent the state of engineering at the time of publishing. We reserve the right to make modifications to the specifications and materials.

31.01.2023